

B30 ————— 6 – 11

B74 ————— 12 – 17

B77 ————— 18 – 23

B78 ————— 24 – 29

B79 ————— 30 – 35

F30 ————— 36 – 39

P30 ————— 40 – 45

P65 ————— 46 – 51

P65 IP54 ————— 52 – 57

Q65 ————— 58 – 63

We don't make lighting. We create atmosphere.

We build long-term relationships based on trust and openness. We dedicate time and attention to every project, because we understand that each one begins with a clear vision and expectations. We listen carefully to every detail and ensure that the final result reflects that vision as precisely as possible.

Our work reflects a passion for lighting.



A TRULY PERSONAL APPROACH

Lighting designed for each space — never the other way around. This is a discipline we have been refining for many years, and one in which we effectively start from the beginning with every project: from initial consultation, through bespoke lighting design and project visualisation, to production fully under our control. We focus on detail, allow clients to see our process, and at the same time remain fully independent. What works for you works for us.

Light is something we deeply value at Hygge

Sustainable development and environmental responsibility are not a trend for us — they are our long-term commitment. In design, material selection, and the manufacturing process itself, we consciously minimise energy consumption and environmental impact. We also take pride in our work because it contributes to a brighter future.



WHERE TECHNOLOGY MEETS CRAFTSMANSHIP

Nothing is left to chance. All products are developed directly in-house, combining traditional craftsmanship with modern technologies, including 3D printing. This gives us full control over the production process, which we can adapt to client requirements and the demands of entrusted spaces, without making unnecessary compromises — whether in efficiency, function, aesthetics, or quality.

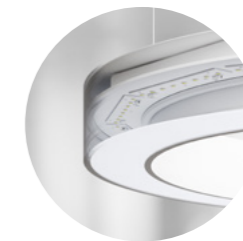

FORM FOLLOWS FUNCTION

Our aluminium luminaires combine timeless design with precise workmanship. Thanks to the high quality of materials, they are easy to install not only in standard but also in atypical locations. All Hygge products meet the latest technological standards and are fully compatible with smart control systems such as DALI, Casambi, and KNX. This ensures that you always have full control over light.



B30



B30

B30 ring luminaires, made from curved aluminium profiles, offer elegant and unobtrusive lighting suitable for minimalist interiors. Their subtle design combines modern aesthetics with functionality. An opal or microprismatic diffuser is available to ensure optimal light distribution depending on the application. The luminaire body is made of an aluminium profile with a width of 30 mm and a finely textured powder-coated finish.

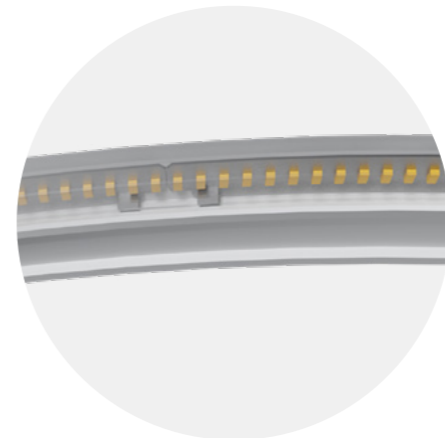

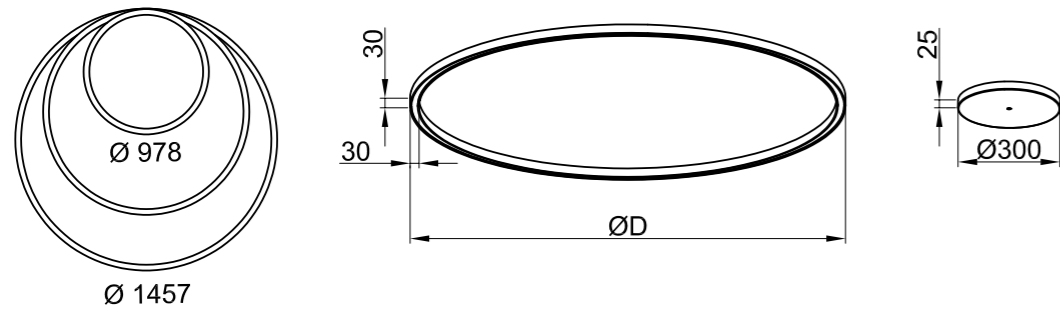

DIFFUSER / OPTICS

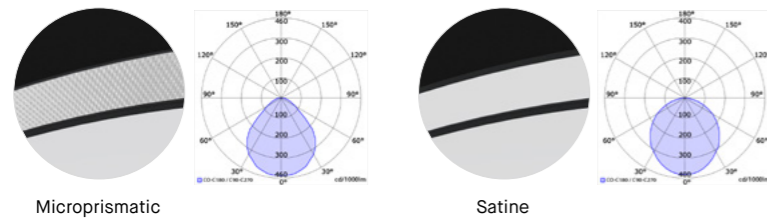

COLOUR FINISH



Name	B30 S
Installation	Suspended
Profile	30 × 30 mm
Version	Set
Diameter	978 / 1213 / 1457 mm
Output	HE high efficiency, HO high output
Diffuser / Optics	Microprismatic, Satine
Light distribution	Direct
CCT	3000K, 4000K
CRI	80, 90
Control *	Flexi, DALI, Casambi
Custom options *	TouchDim, EM1, EM3, Zigbee, sensor, RF
LED lifetime	L80/B20 - 80 000h
Finish	Finely textured powder-coated finish
Susp. / Power cable length	1500 mm

* Custom options and control must be specified individually.





B74

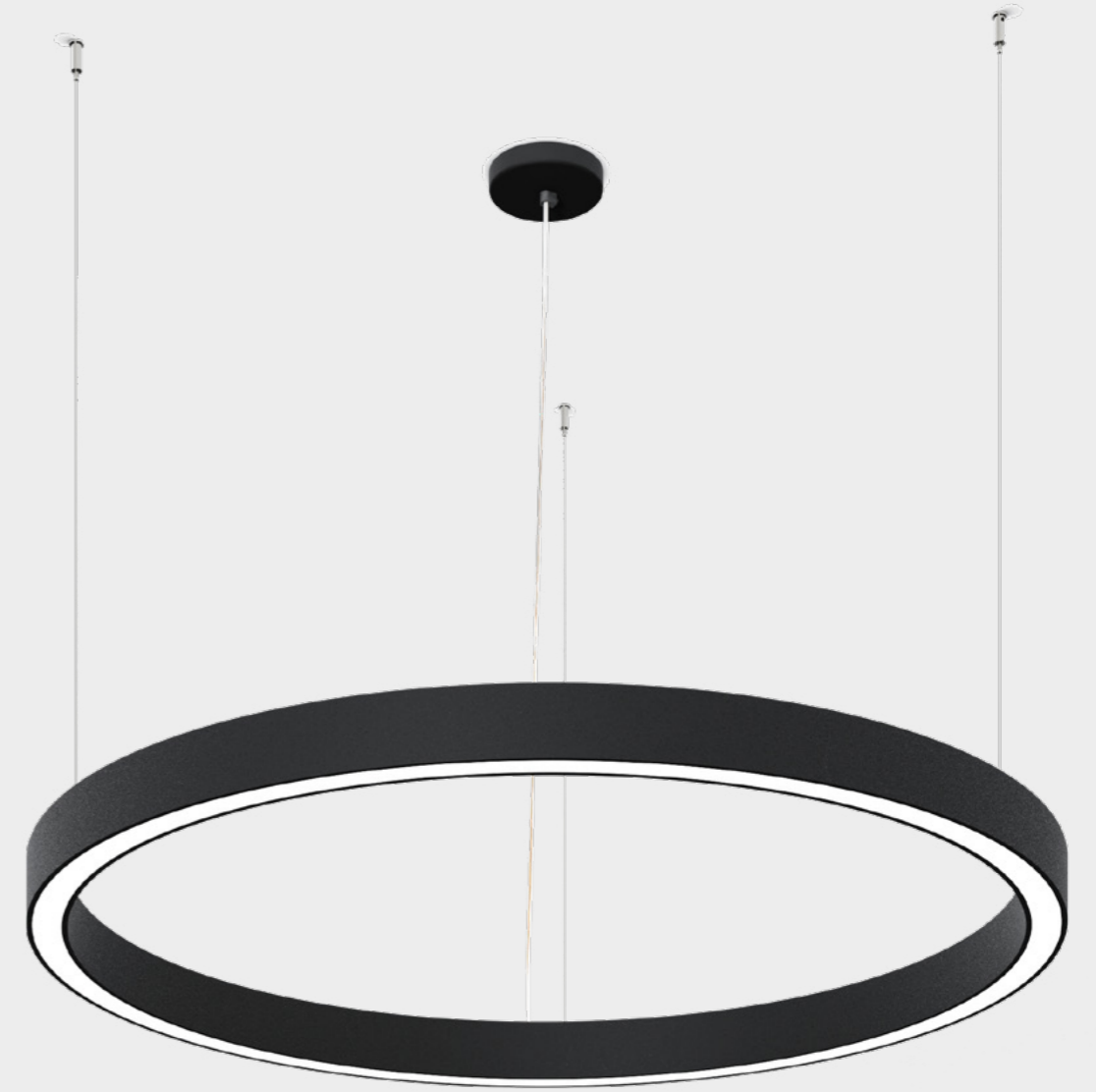
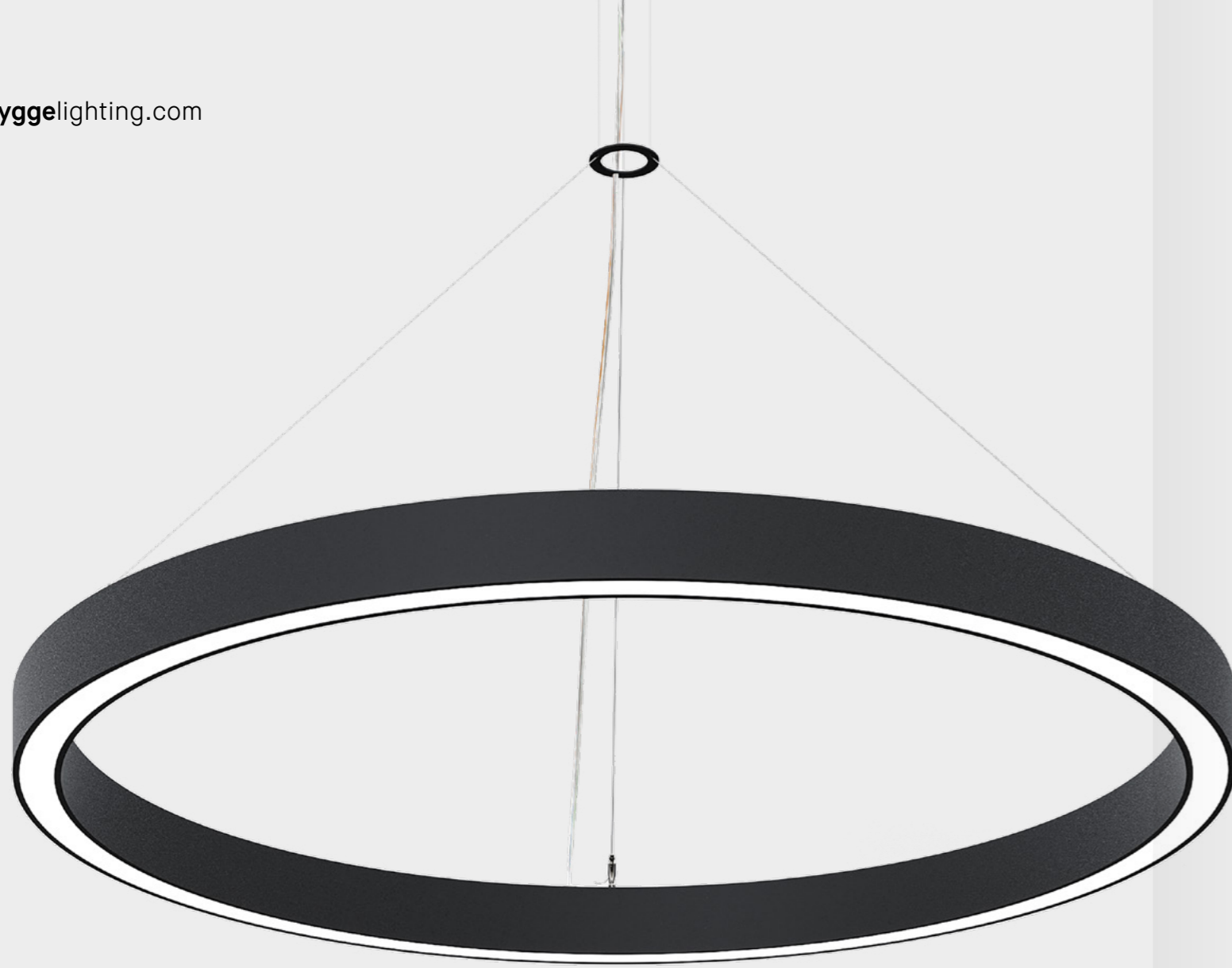

B74

B74 ring luminaires with a modern and subtle design gently emphasise the architectural concept of a space. They are supplied in a suspended version with direct or direct/indirect light distribution, with an opal or microprismatic diffuser. The luminaire body is made of an aluminium profile with a width of 48 mm and a finely textured powder-coated finish.

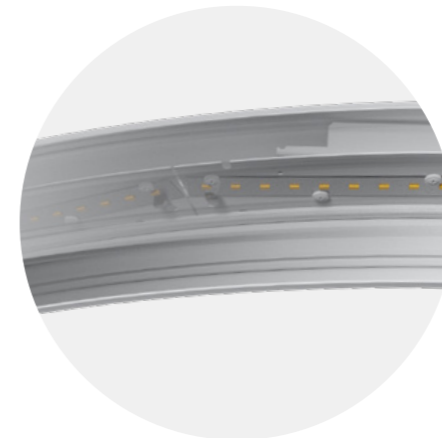

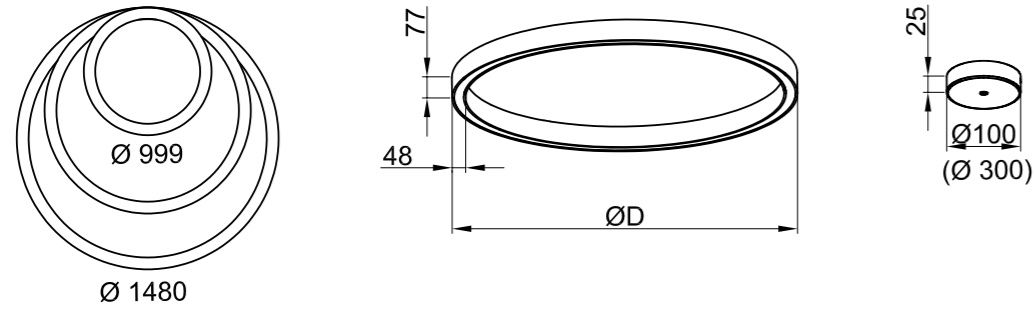

DIFFUSER / OPTICS

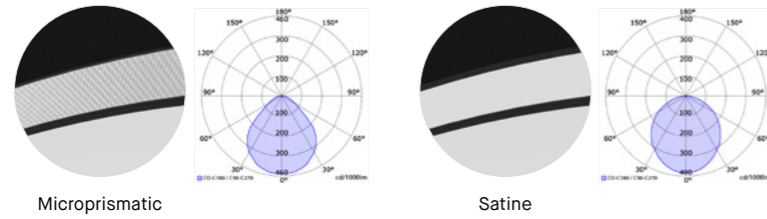

COLOUR FINISH

RAL9003

RAL9005

RAL9006

RAL

Name	B74 S
Installation	Suspended
Profile	48 × 77 mm
Version	Set / System
Diameter	999 / 1235 / 1480 mm
Output	HE high efficiency, HO high output
Diffuser / Optics	Microprismatic, Satine
Light distribution	Direct, Direct/indirect
CCT	3000K, 4000K
CRI	80, 90
Control *	Flexi, DALI, Casambi
Custom options *	TouchDim, EM1, EM3, Zigbee, sensor, RF
LED lifetime	L80/B20 - 80 000h
Finish	Finely textured powder-coated finish
Susp. / Power cable length	1500 mm

* Custom options and control must be specified individually.

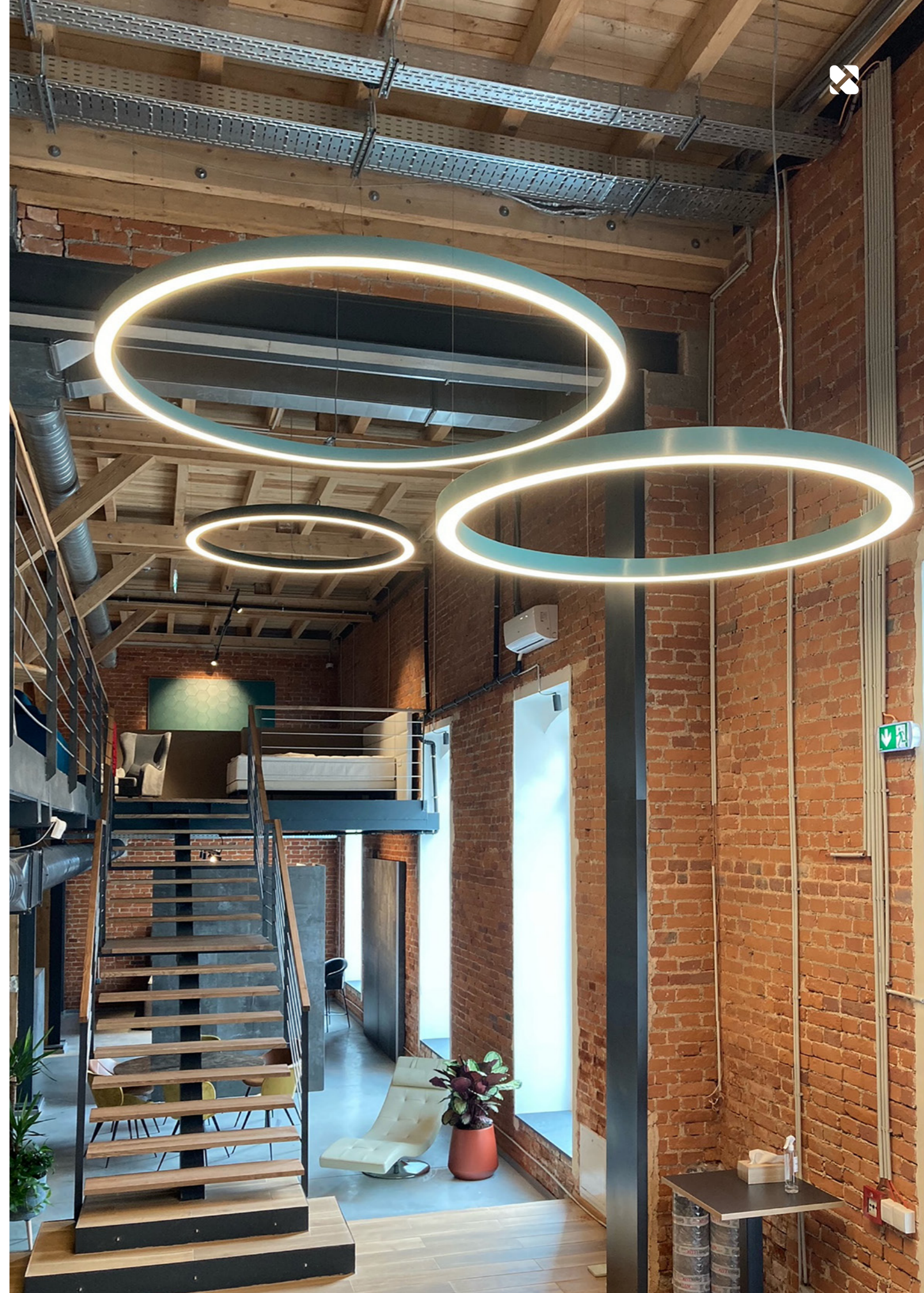



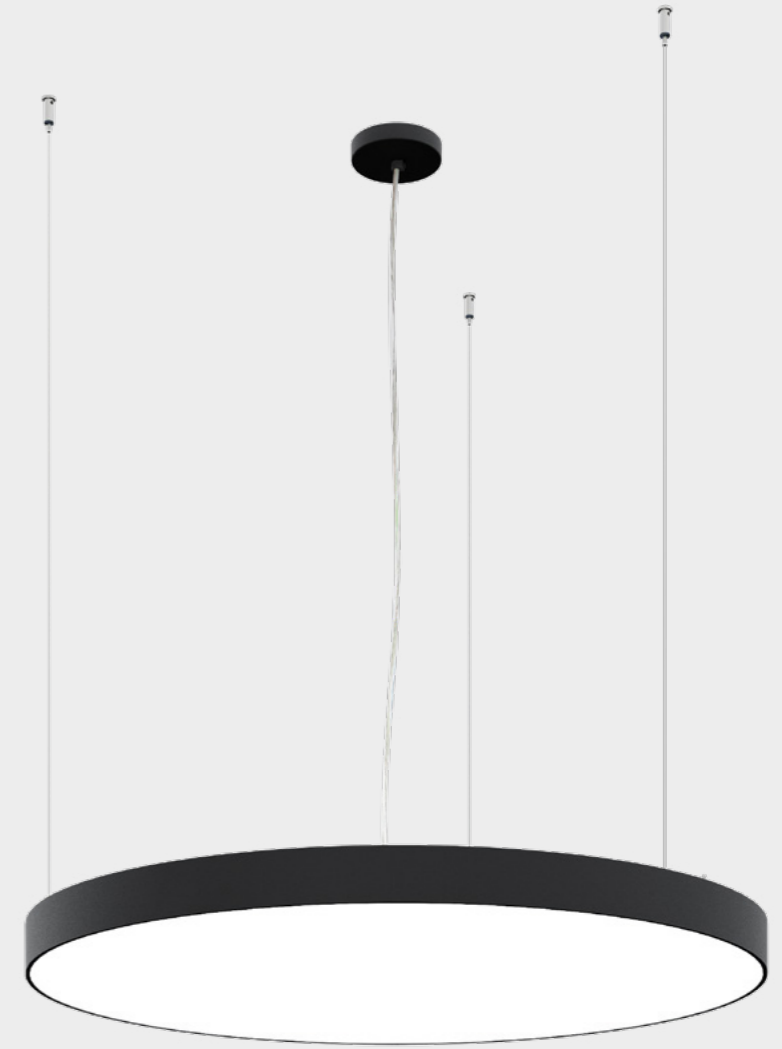

B77

B77 circular luminaires with a minimalist design help designers and architects create a pleasant lighting atmosphere in interior spaces. They are supplied in surface-mounted and suspended versions with direct or direct/indirect light distribution, with an opal or microprismatic diffuser. The luminaire body is made of an aluminium profile with a height of 77 mm and a finely textured powder-coated finish.

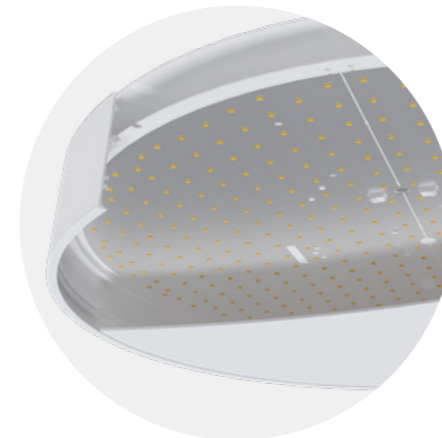



COLOUR FINISH

RAL9003

RAL9005

RAL9006

RAL

Name	B77 S	B77 C
Installation	Suspended	Surface-mounted
Profile height	77 mm	77 mm
Version	Set	Set
Diameter	252 / 300 / 345 / 444 / 555 / 858 / 1144 mm	252 / 300 / 345 / 444 / 555 / 858 / 1144 mm
Output	HE high efficiency, HO high output, XHO extra high output	HE high efficiency, HO high output, XHO extra high output
Diffuser / Optics	Satine, MicroSat, Microprismatic	Satine, MicroSat, Microprismatic
Light distribution	Direct, Direct/indirect	Direct, Direct/indirect
CCT	3000K, 4000K, 2700-6500K	3000K, 4000K, 2700-6500K
CRI	80, 90	80, 90
Control *	Flexi, DALI, Casambi, DALI TW, Casambi TW	Flexi, DALI, Casambi, DALI TW, Casambi TW
Custom options *	TouchDim, EM1, EM3, Zigbee, sensor, RF	TouchDim, EM1, EM3, Zigbee, sensor, RF
LED lifetime	L80/B20 - 80 000h	L80/B20 - 80 000h
Finish	Finely textured powder-coated finish	Finely textured powder-coated finish
Susp. / Power cable length	1500 mm	

* Custom options and control must be specified individually.

DIFFUSER / OPTICS



Microprismatic

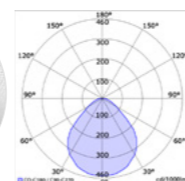

Satine

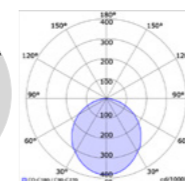

PRODUCT CONFIGURATOR

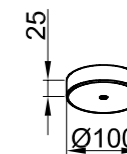
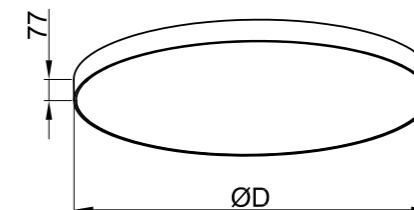
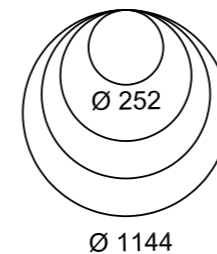

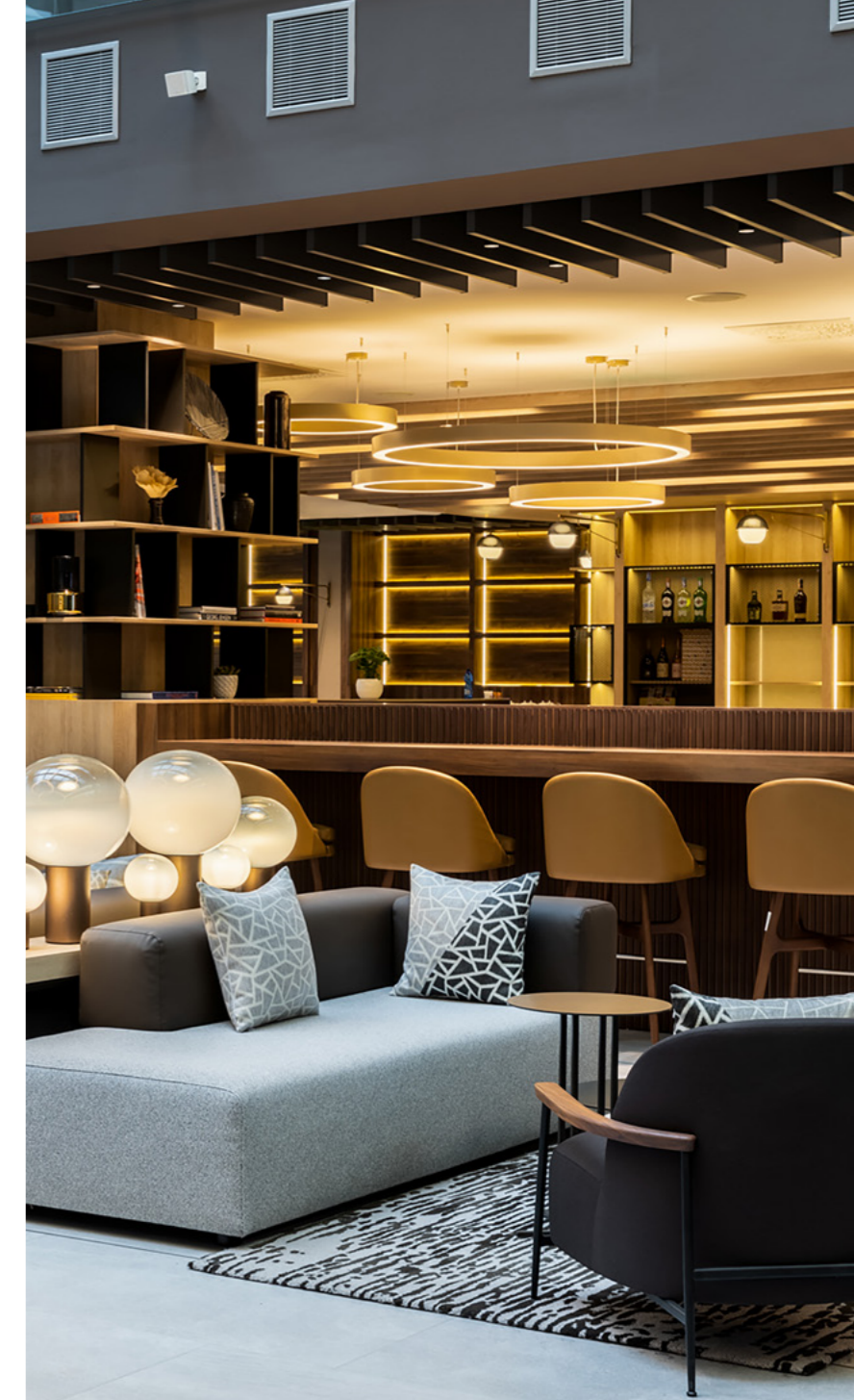

B78

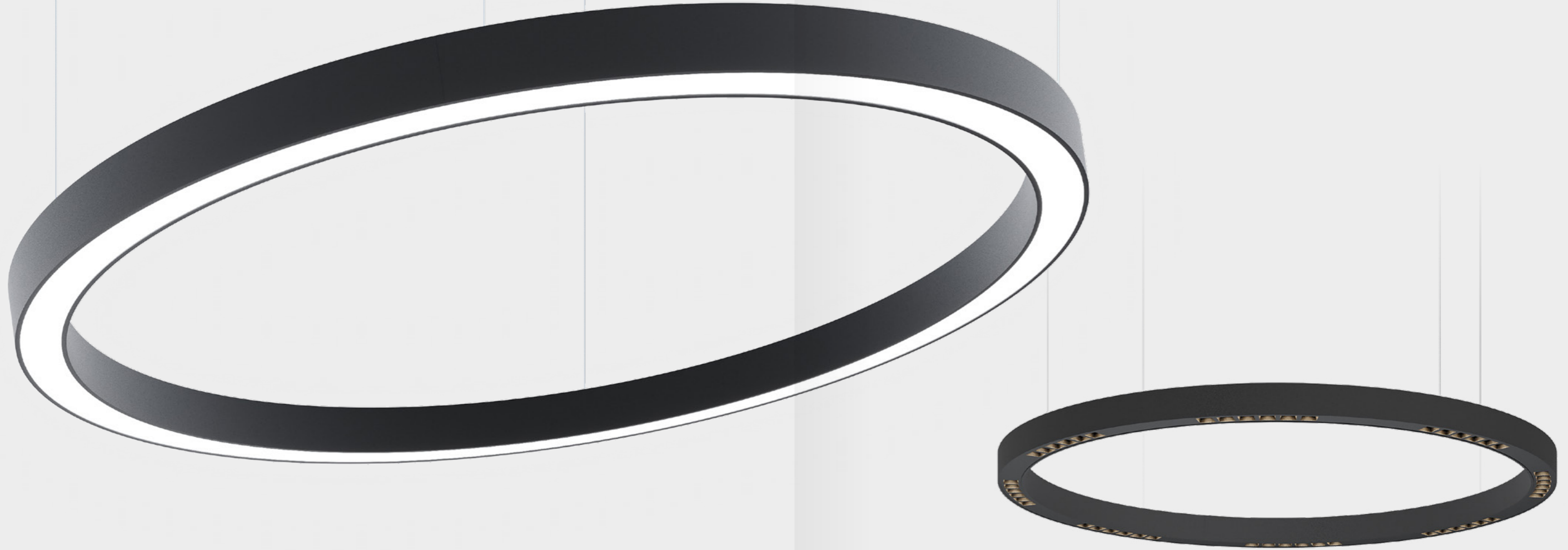

B78

B78 ring luminaires act as a dominant design element emphasising the architectural concept of a space. They are supplied in surface-mounted and suspended versions with direct or direct/indirect light distribution, with an opal or microprismatic diffuser or glare-reducing optics (UGR). The luminaire body is made of an aluminium profile with a width of 70 mm and a finely textured powder-coated finish.

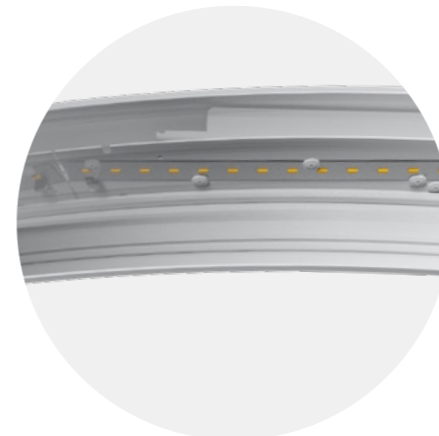



COLOUR FINISH

- RAL9003
- RAL9005
- RAL9006
- RAL

Name	B78 S	B78 C
Installation	Suspended	Surface-mounted
Profile	70 × 77 mm	70 × 77 mm
Version	Set	Set
Diameter	444 / 585 / 770 / 980 / 1240 / 1519 / 1980 / 2520 / 2965 / 4130 mm	444 / 585 / 770 / 980 / 1240 / 1519 / 1980 / 2520 / 2965 / 4130 mm
Output	HE high efficiency, HO high output, XHO extra high output	HE high efficiency, HO high output, XHO extra high output
Diffuser / Optics	Satine, MicroSat, Microprismatic, Glare-reducing optics (UGR)	Satine, MicroSat, Microprismatic, Glare-reducing optics (UGR)
Light distribution	Direct, Direct/indirect	Direct
CCT	3000K, 4000K, 2700-6500K	3000K, 4000K, 2700-6500K
CRI	80, 90	80, 90
Control *	Flexi, DALI, Casambi, DALI TW, Casambi TW	Flexi, DALI, Casambi, DALI TW, Casambi TW
Custom options *	TouchDim, EM1, EM3, Zigbee, sensor, RF	TouchDim, EM1, EM3, Zigbee, sensor, RF
LED lifetime	L80/B20 - 80 000h	L80/B20 - 80 000h
Finish	Finely textured powder-coated finish	Finely textured powder-coated finish
Susp. / Power cable length	1500 mm	

* Custom options and control must be specified individually.

DIFFUSER / OPTICS

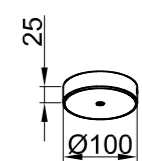
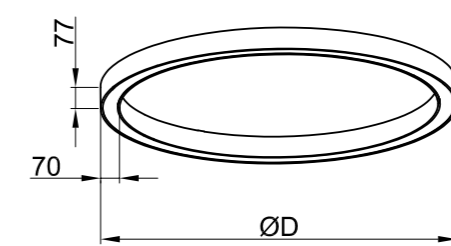
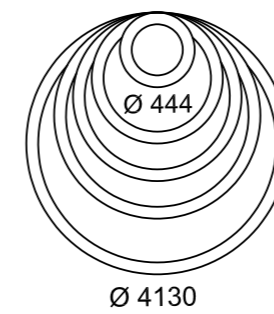
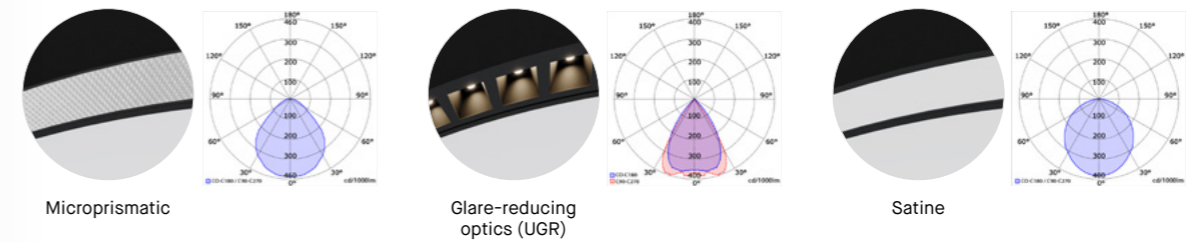



B7g

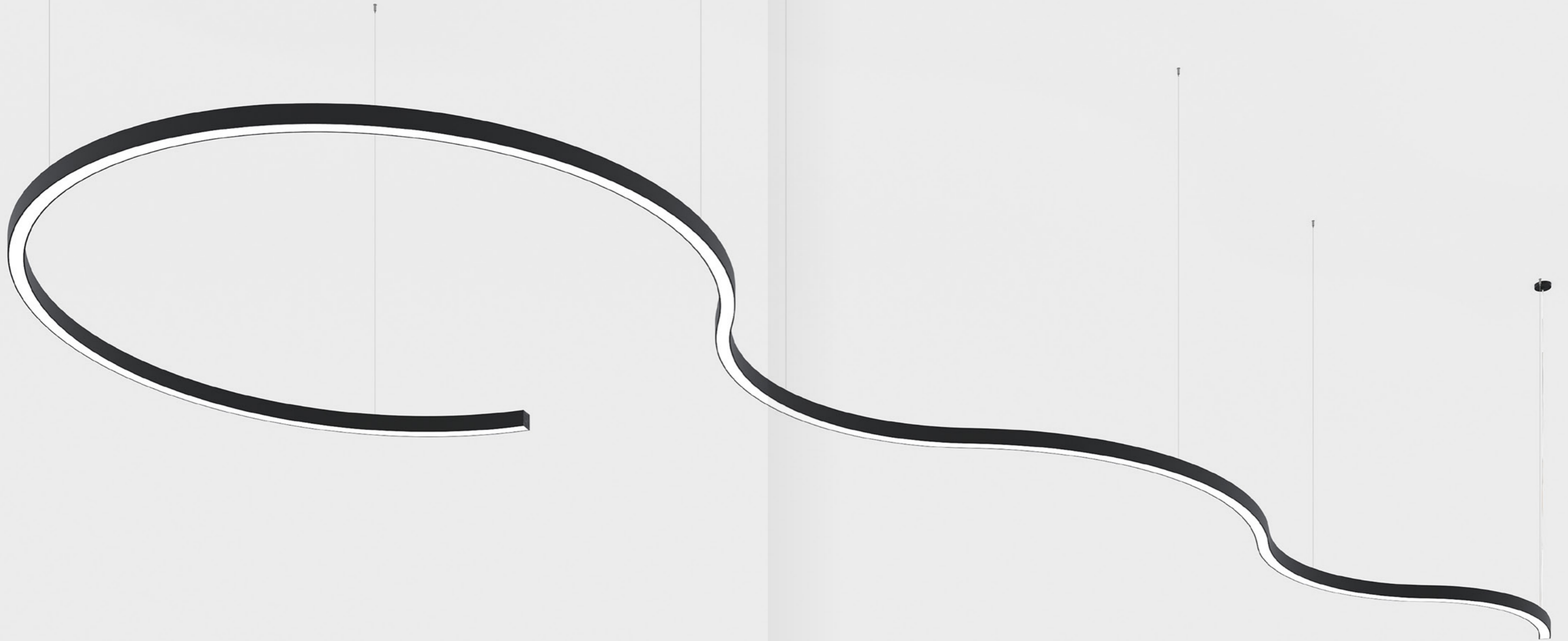

B79

B79 luminaires enable the creation of original lighting compositions and create the impression of painting with light in an interior. Thanks to the possibility of combining curved profiles, smooth lighting curves of various shapes can be created. These luminaires are supplied in suspended or surface-mounted versions with direct or direct/indirect light distribution. The luminaire body is made of an aluminium profile with a width of 70 mm and a finely textured powder-coated finish.

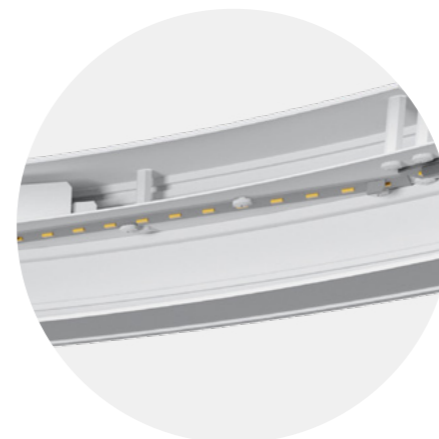



COLOUR FINISH

RAL9003

RAL9005

RAL9006

RAL

Name	B79 S	B79 C
Installation	Suspended	Surface-mounted
Profile	70 × 77 mm	70 × 77 mm
Version	System	System
Radius	490 / 760 / 990 / 1483 mm	490 / 760 / 990 / 1483 mm
Output	HE high efficiency, HO high output, XHO extra high output	HE high efficiency, HO high output, XHO extra high output
Diffuser / Optics	Satine, MicroSat, Microprismatic, Glare-reducing optics (UGR)	Satine, MicroSat, Microprismatic, Glare-reducing optics (UGR)
Light distribution	Direct, Direct/indirect	Direct
CCT	3000K, 4000K, 2700-6500K	3000K, 4000K, 2700-6500K
CRI	80, 90	80, 90
Control *	Flexi, DALI, Casambi, DALI TW, Casambi TW	Flexi, DALI, Casambi, DALI TW, Casambi TW
Custom options *	TouchDim, EM1, EM3, Zigbee, sensor, RF	TouchDim, EM1, EM3, Zigbee, sensor, RF
LED lifetime	L80/B20 - 80 000h	L80/B20 - 80 000h
Finish	Finely textured powder-coated finish	Finely textured powder-coated finish
Susp. / Power cable length	1500 mm	

* Custom options and control must be specified individually.

DIFFUSER / OPTICS



Microprismatic

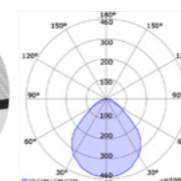

Glare-reducing optics (UGR)

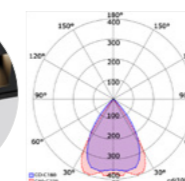

Satine

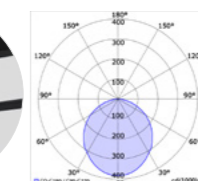

PRODUCT CONFIGURATOR

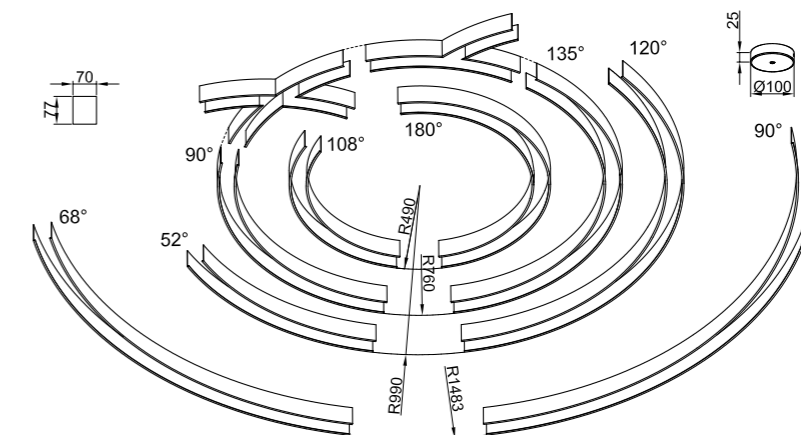



F30



DIFFUSER / OPTICS

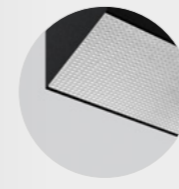

Microprismatic

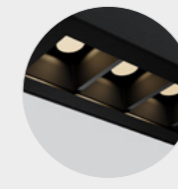

Glare-reducing optics (UGR)



Opal

COLOUR FINISH

- RAL9003
- RAL9005
- RAL9006
- RAL

Name	F30 F
Installation	Floor-standing
Profile	30 x 30 mm
Version	Set
Height	1800 mm
Output	HE high efficiency, HO high output
Diffuser / Optics	Microprismatic, Glare-reducing optics (UGR), Opal
Light distribution	Direct, Direct/indirect
CCT	3000K, 4000K
CRI	80, 90
Control *	Flexi, DALI, Casambi
Custom options *	TouchDim, sensor
LED lifetime	L80/B20 - 80 000h
Finish	Finely textured powder-coated finish

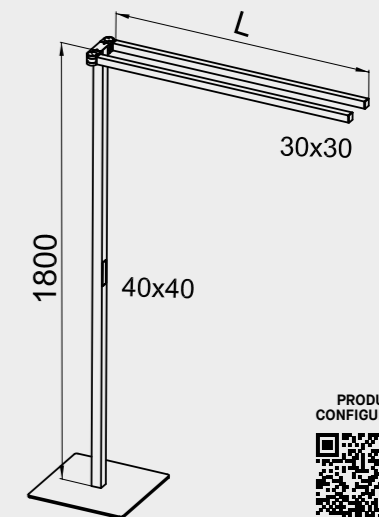

* Custom options and control must be specified individually.

F30

The F30 floor luminaire combines modern design with high-performance lighting suitable for offices, living spaces, and work environments. Thanks to an integrated joint, it allows easy adjustment of the direction of light according to the current needs of the user. It provides both direct and direct/indirect lighting, where the indirect component is created by rotating one of the arms upwards. An opal or microprismatic diffuser is available, as well as glare-reducing optics (UGR) for high visual comfort. The luminaire body is made of an aluminium profile with a finely textured powder-coated finish.





PRO



P30

P30 linear luminaires represent a modern lighting solution for a wide range of spaces. Thanks to their slim profile, they appear elegant and unobtrusive in interiors. An opal or microprismatic diffuser is available, as well as glare-reducing optics (UGR) for high visual comfort. The luminaires are equipped with modern LED modules with high efficiency and long lifetime. The luminaire body with a width of 30 mm is made of an aluminium profile with a finely textured powder-coated finish.

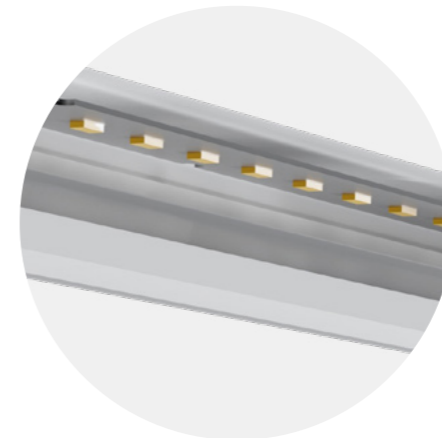

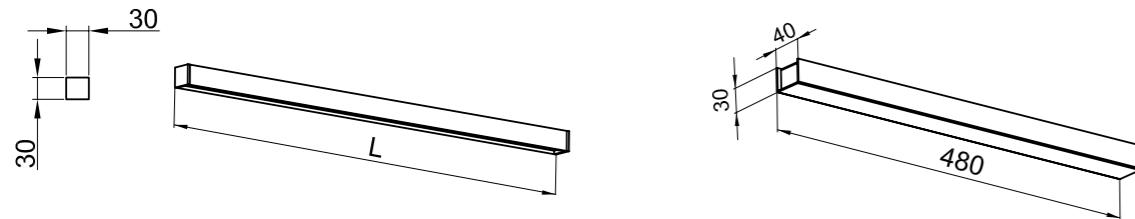

DIFFUSER / OPTICS

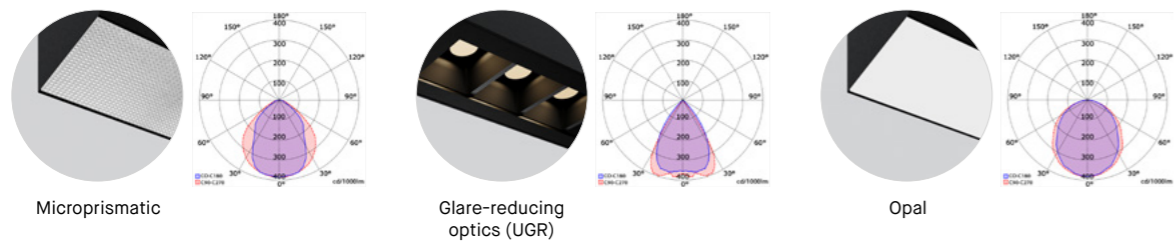

COLOUR FINISH



Name	P30 S
Installation	Suspended
Profile	30 × 30 mm
Version	Set
Length	562 / 842 / 1122 / 1402 / 1682 / 1962 / 2242 mm
Output	HE high efficiency, HO high output
Diffuser / Optics	Microprismatic, Glare-reducing optics (UGR), Opal
Light distribution	Direct
CCT	3000K, 4000K
CRI	80, 90
Control *	Flexi, DALI, Casambi
Custom options *	TouchDim, EM1, EM3, Zigbee, sensor, RF
LED lifetime	L80/B20 - 80 000h
Finish	Finely textured powder-coated finish
Susp. / Power cable length	1500 mm

* Custom options and control must be specified individually.





PROS



P65

P65 linear luminaires represent a variable and efficient lighting solution for a wide range of environments. They are designed as system luminaires that allow interconnection and the creation of linear and shaped configurations using L, T, and X connectors. They offer direct as well as direct/indirect light distribution and various installation methods: suspended, surface-mounted, wall-mounted, and recessed. An opal or microprismatic diffuser is available, as well as glare-reducing optics (UGR) for optimal light distribution depending on the application. The luminaire body with a width of 64 mm is made of an aluminium profile with a finely textured powder-coated finish and an IP40 rating.



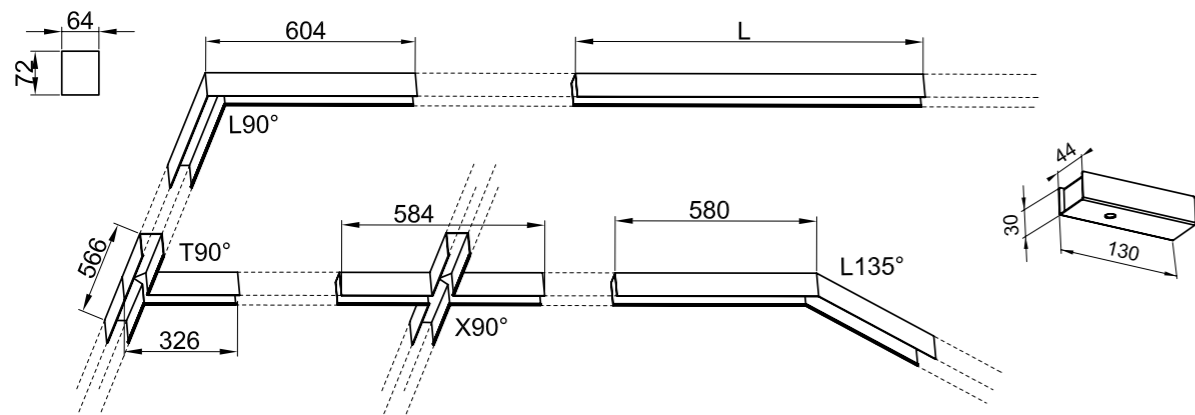

Name	P65 W	P65 S
Installation	Wall-mounted	Suspended
Profile	64 × 72 mm	64 × 72 mm
Version	Set / System	Set / System
Length	562 / 842 / 1122 / 1402 / 1682 / 1962 / 2242 mm	562 / 842 / 1122 / 1402 / 1682 / 1962 / 2242 mm
Output	HE high efficiency, HO high output, XHO extra high output	HE high efficiency, HO high output, XHO extra high output
Diffuser / Optics	Microprismatic, Glare-reducing optics (UGR), Opal	Microprismatic, Glare-reducing optics (UGR), Opal
Light distribution	Direct, Direct/indirect	Direct, Direct/indirect
CCT	3000K, 4000K, 2700-6500K	3000K, 4000K, 2700-6500K
CRI	80, 90	80, 90
Control *	Flexi, DALI, Casambi, DALI TW, Casambi TW	Flexi, DALI, Casambi, DALI TW, Casambi TW
Custom options *	TouchDim, EM1, EM3, Zigbee, sensor, RF	TouchDim, EM1, EM3, Zigbee, sensor, RF
LED lifetime	L80/B20 - 80 000h	L80/B20 - 80 000h
Finish	Finely textured powder-coated finish	Finely textured powder-coated finish
Susp. / Power cable length		1500 mm

* Custom options and control must be specified individually.

COLOUR FINISH



DIFFUSER / OPTICS

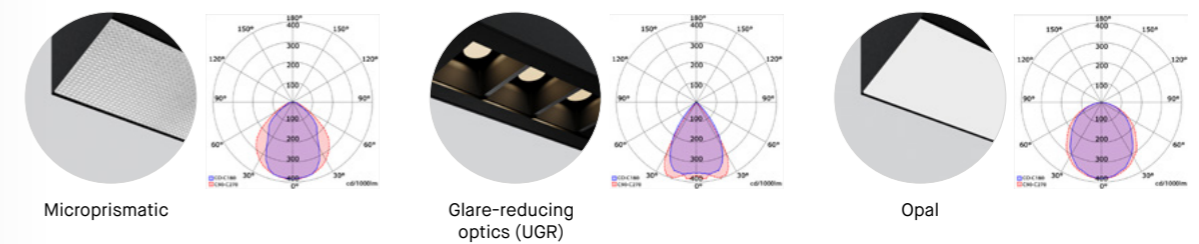

Name	P65 C	P65 R
Installation	Surface-mounted	Recessed
Profile	64 × 72 mm	64 × 72 mm
Version	Set / System	Set / System
Length	562 / 842 / 1122 / 1402 / 1682 / 1962 / 2242 mm	562 / 842 / 1122 / 1402 / 1682 / 1962 / 2242 mm
Output	HE high efficiency, HO high output, XHO extra high output	HE high efficiency, HO high output, XHO extra high output
Diffuser / Optics	Microprismatic, Glare-reducing optics (UGR), Opal	Microprismatic, Glare-reducing optics (UGR), Opal
Light distribution	Direct	Direct
CCT	3000K, 4000K, 2700-6500K	3000K, 4000K, 2700-6500K
CRI	80, 90	80, 90
Control *	Flexi, DALI, Casambi, DALI TW, Casambi TW	Flexi, DALI, Casambi, DALI TW, Casambi TW
Custom options *	TouchDim, EM1, EM3, Zigbee, sensor, RF	TouchDim, EM1, EM3, Zigbee, sensor, RF
LED lifetime	L80/B20 - 80 000h	L80/B20 - 80 000h
Finish	Finely textured powder-coated finish	Finely textured powder-coated finish
Susp. / Power cable length		

* Custom options and control must be specified individually.



PRO5 IP54



P65^{IP54}

P65 IP54 linear luminaires represent a durable and efficient lighting solution for more demanding environments. They provide direct light distribution and are available in suspended, surface-mounted, and wall-mounted versions. An opal or microprismatic diffuser is available to ensure optimal light distribution depending on the application. The IP54 rating provides increased protection against dust and moisture, making these luminaires suitable for demanding interior spaces, covered outdoor areas, or environments with higher cleanliness requirements. The luminaire body with a width of 64 mm is made of an aluminium profile with a finely textured powder-coated finish.

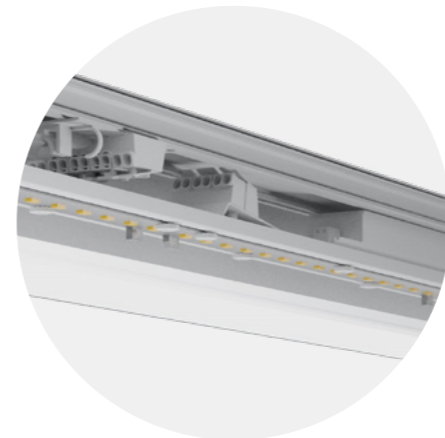



COLOUR FINISH

- RAL9003
- RAL9005
- RAL9006
- RAL



Name	P65 IP54 W	P65 IP54 S
Installation	Wall-mounted	Suspended
Profile	64 × 76 mm	64 × 76 mm
Version	Set	Set
Length	600 / 880 / 1160 / 1440 / 1720 mm	600 / 880 / 1160 / 1440 / 1720 mm
Output	HE high efficiency, HO high output, XHO extra high output	HE high efficiency, HO high output, XHO extra high output
Diffuser / Optics	Opal, Microprismatic	Opal, Microprismatic
Light distribution	Direct	Direct
CCT	3000K, 4000K, 2700-6500K	3000K, 4000K, 2700-6500K
CRI	80, 90	80, 90
Control *	Flexi, DALI	Flexi, DALI
Custom options *	Casambi, DALI TW, Casambi TW, TouchDim, EM1, EM3, Zigbee, sensor, RF	Casambi, DALI TW, Casambi TW, TouchDim, EM1, EM3, Zigbee, sensor, RF
LED lifetime	L80/B20 - 80 000h	L80/B20 - 80 000h
Finish	Finely textured powder-coated finish	Finely textured powder-coated finish
Susp. / Power cable length		1500 mm

* Custom options and control must be specified individually.

DIFFUSER / OPTICS

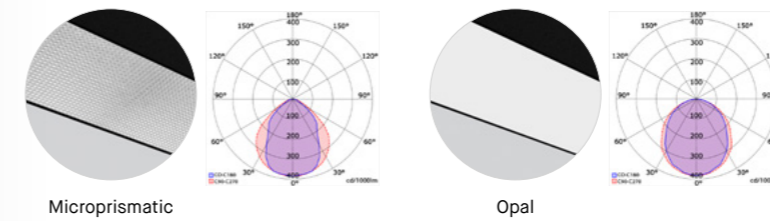

Name	P65 IP54 C
Installation	Surface-mounted
Profile	64 × 76 mm
Version	Set
Length	600 / 880 / 1160 / 1440 / 1720 mm
Output	HE high efficiency, HO high output, XHO extra high output
Diffuser / Optics	Microprismatic, Opal
Light distribution	Direct
CCT	3000K, 4000K, 2700-6500K
CRI	80, 90
Control *	Flexi, DALI
Custom options *	Casambi, DALI TW, Casambi TW, TouchDim, EM1, EM3, Zigbee, sensor, RF
LED lifetime	L80/B20 - 80 000h
Finish	Finely textured powder-coated finish
Susp. / Power cable length	

* Custom options and control must be specified individually.



PRODUCT CONFIGURATOR



Q65

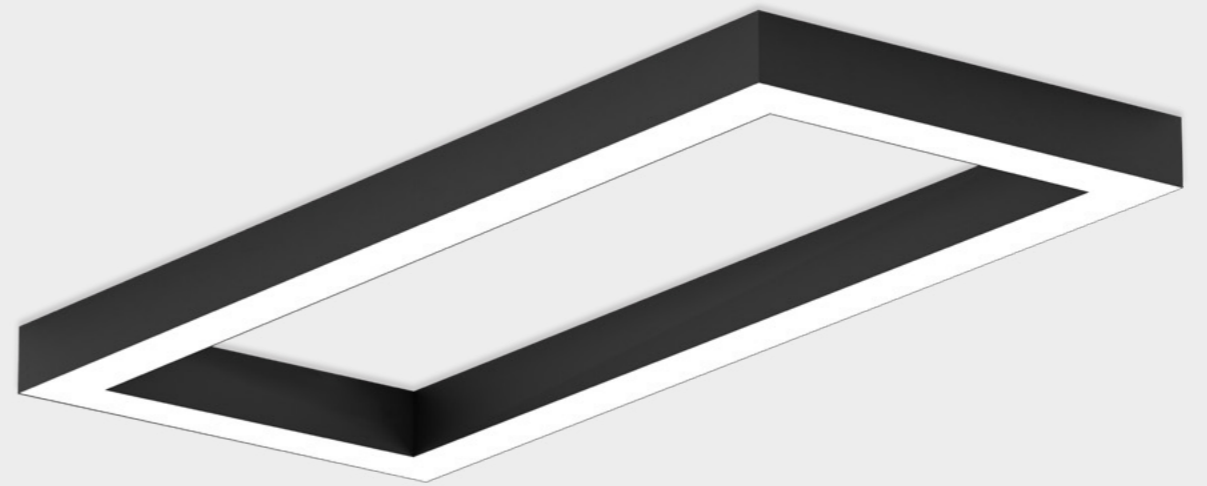
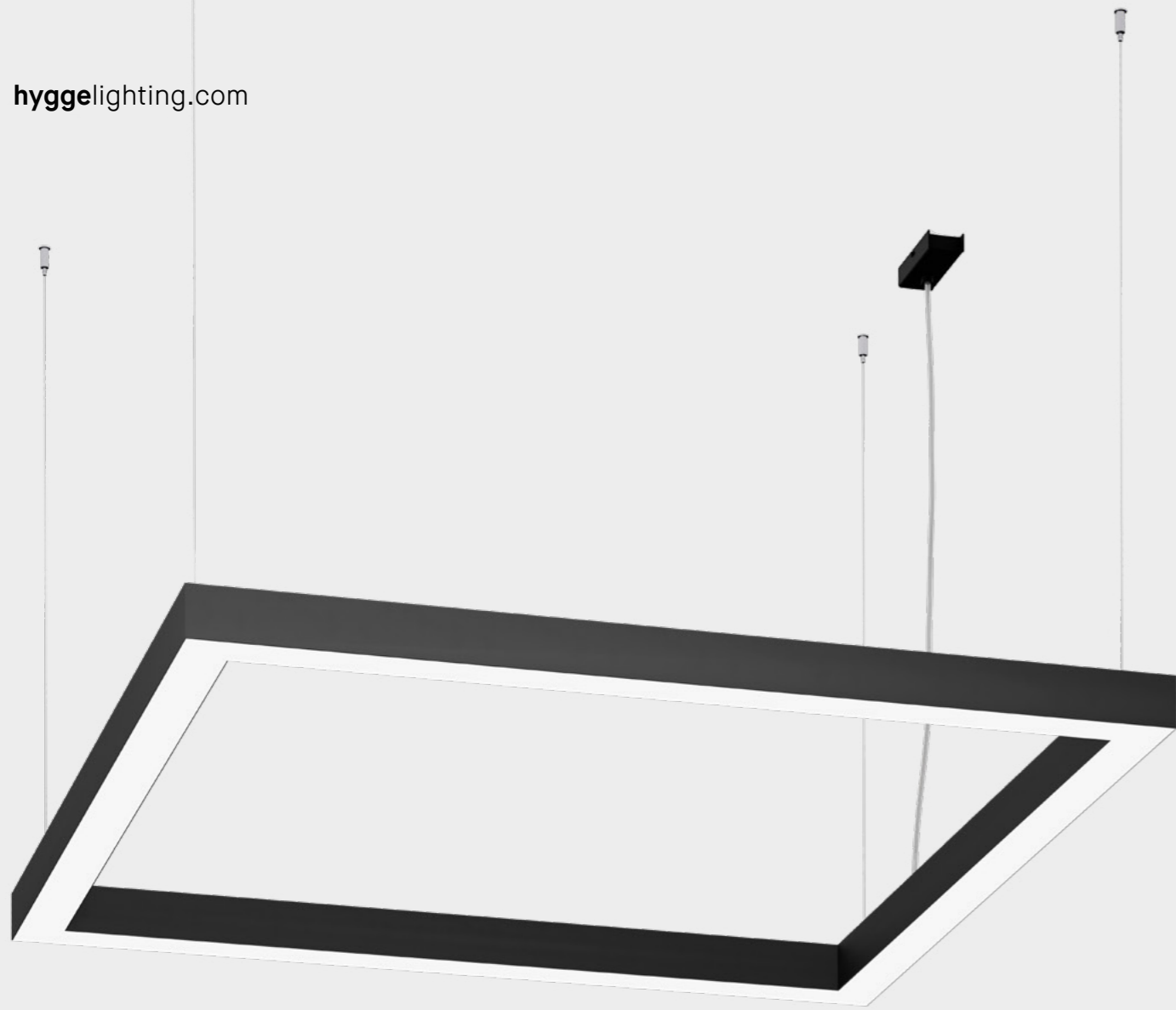

Q65

Q65 luminaires in square or rectangular configurations bring a distinctive geometric element and uniform illumination into interior spaces. They are available in surface-mounted or suspended versions with direct or direct/indirect light distribution. An opal or microprismatic diffuser is available to ensure optimal light distribution depending on the application. The luminaire body is made of an aluminium profile with a width of 64 mm and a finely textured powder-coated finish.

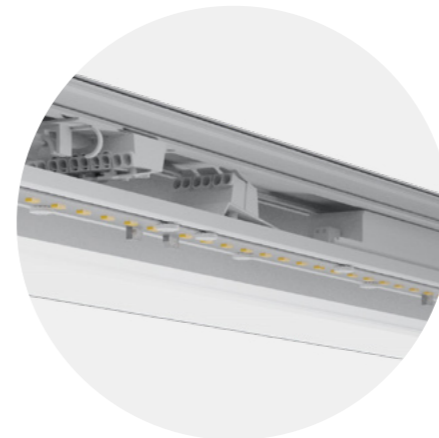



DIFFUSER / OPTICS

Microprismatic

Glare-reducing optics (UGR)

Opal

PRODUCT CONFIGURATOR

COLOUR FINISH

RAL9003

RAL9005

RAL9006

RAL

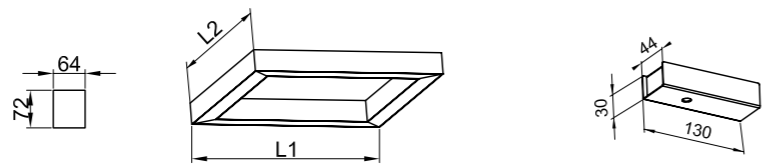

Name	Q65 S	Q65 C
Installation	Suspended	Surface-mounted
Profile	64 × 72 mm	64 × 72 mm
Version	Set	Set
Length	652 × 652 / 1212 × 652 / 1212 × 1212 mm	652 × 652 / 1212 × 652 / 1212 × 1212 mm
Output	HE high efficiency, HO high output	HE high efficiency, HO high output
Diffuser / Optics	Microprismatic, Glare-reducing optics (UGR), Opal	Microprismatic, Glare-reducing optics (UGR), Opal
Light distribution	Direct, Direct/indirect	Direct
CCT	3000K, 4000K	3000K, 4000K
CRI	80, 90	80, 90
Control *	Flexi, DALI, Casambi	Flexi, DALI, Casambi
Custom options *	TouchDim, EM1, EM3, Zigbee, sensor, RF	TouchDim, EM1, EM3, Zigbee, sensor, RF
LED lifetime	L80/B20 - 80 000h	L80/B20 - 80 000h
Finish	Finely textured powder-coated finish	Finely textured powder-coated finish
Susp. / Power cable length	1500 mm	

* Custom options and control must be specified individually.





Hygge lighting s.r.o.
Mojmírova 1237
686 01 Uherské Hradiště
Czech Republic

hyggelighting.com